



HAL
open science

Dark Count rate measurement in Geiger mode and simulation of a photodiode array, with CMOS 0.35 technology and transistor quenching.

D Pellion, K Jradi, N Brochard, D Prêle, Dominique Ginhac

► To cite this version:

D Pellion, K Jradi, N Brochard, D Prêle, Dominique Ginhac. Dark Count rate measurement in Geiger mode and simulation of a photodiode array, with CMOS 0.35 technology and transistor quenching.. 7th international conference on New Developments in Photodetection, Jun 2014, Tours, France. hal-01196632

HAL Id: hal-01196632

<https://u-bourgogne.hal.science/hal-01196632>

Submitted on 10 Sep 2015

HAL is a multi-disciplinary open access archive for the deposit and dissemination of scientific research documents, whether they are published or not. The documents may come from teaching and research institutions in France or abroad, or from public or private research centers.

L'archive ouverte pluridisciplinaire **HAL**, est destinée au dépôt et à la diffusion de documents scientifiques de niveau recherche, publiés ou non, émanant des établissements d'enseignement et de recherche français ou étrangers, des laboratoires publics ou privés.

1 Dark Count rate measurement in Geiger
2 mode and simulation of a photodiode array,
3 with CMOS 0.35 technology and
4 transistorquenching.

5 D. Pellion¹, K. Jradi¹, N. Brochard¹, D. Prêle², D. Ginhac¹

6

7 1: Le2i - CNRS/Univ. de Bourgogne, Dijon, France

8 2: APC - CNRS/Univ. Paris Diderot, Paris, France

9

10

11

12

13

14

15

16

17

18

19

20

21

22

23

24

25

26

27

28

29 *Abstract:*

30

31 Some decades ago single photon detection used to be the terrain of photomultiplier tube
32 (PMT), thanks to its characteristics of sensitivity and speed. However, PMT has several
33 disadvantages such as low quantum efficiency, overall dimensions, and cost, making
34 them unsuitable for compact design of integrated systems. So, the past decade has seen a
35 dramatic increase in interest in new integrated single-photon detectors called Single-
36 Photon Avalanche Diodes (SPAD) or Geiger-mode APD. SPAD detectors fabricated in a
37 standard CMOS technology feature both single-photon sensitivity, and excellent timing
38 resolution, while guaranteeing a high integration. SPAD are working in avalanche mode
39 above the breakdown level. When an incident photon is captured, a very fast avalanche
40 is triggered, generating an easily detectable current pulse.

41 In this work, we investigate the design of SPAD detectors using the austrian microsystems'
42 0.35 μm CMOS Optotechnology. A series of different SPADs has been fabricated and
43 benchmarked in order to evaluate a future integration into a SPAD-based image sensor.
44 The main characteristics of each SPAD operating in Geiger-mode are reported: current
45 voltage, breakdown voltage as a function of temperature. From this first set of results, a
46 detailed study of the Dark Count Rate (DCR) has been conducted.

47 Our results show a dark count rate increase with the size of the photodiodes and the
48 temperature (at $T=22.5^\circ\text{C}$, the DCR of a $10\mu\text{m}$ -photodiode is 2020count.s^{-1} while it is
49 270count.s^{-1} at $T=-40^\circ\text{C}$ for a overvoltage of 800mV).

50 We found that the adjustment of overvoltage is very sensitive and depends on the
51 temperature. The temperature will be adjusted for the subsequent experiments. A
52 mathematical model is presented for reproduce the DCR of a single photodiode. We
53 simulated the noise (DCR) of array of 32×32 photo-detectors. Our results show, of course
54 an increase of DCR of 1024, but especially, the probability of having two pulses
55 simultaneously is 0 (without light). By studying these probabilities of occurrence of the
56 pulses, we think we can reduce the DCR of 50% with a statistical method and reduce the
57 crosstalk of 90%. This study is realized in order to prepare the first digital matrices
58 sensor in Geiger mode.

59

60

61

62 **1 Introduction**

63 The Geiger-mode APD is a new semiconductor photon sensor, which has a high photon
64 counting capability. The system is described in detail in [Ref 1]. The Silicon
65 Photomultiplier (SiPM) is a multi-cell silicon photodiode (typical cell size is from $D = 10$
66 to $50\mu\text{m}$) joined together on a common substrate and working on a common load. The
67 silicon avalanche microcells with very low noise current are operated in the Geiger
68 mode, in which the bias voltage is above the diode breakdown voltage (typical $V_{br} = 10$ to
69 100V). The typical density of microcells is $400\text{--}5000$ per mm^2 . The first
70 development started about 10 years ago in Russia [Ref 2]. Hamamatsu Photonics
71 produces the Multi-Pixel Photon Counter MPPC since 2008. It is a type of SiPM. The SiPM
72 is described in details in [Ref 3]. Currently, several technologies have been developed.
73 Good performances have been measured. A good performance comparison is described
74 in details in [Ref 4][Ref 5]. We introduce in this paper our research in the Geiger mode
75 with the technology "CMOS-Opto C35B401" proposed by CMP (Circuit Multi-Projects) in
76 Grenoble and manufactured by AMS (Austria Micro-system). These sensors, and this
77 operating mode, have a significant defect: a lot of noise. We propose in this paper a DCR
78 study with new measures in order to lessen the noise with new measurements in order
79 to lessen the noise.

80

81 **2 The Technology "CMOS-Opto C35B401", and breakdown voltage** 82 **simulation**

83 This "CMOS-Opto C35B401" process is made with a P-epi-layer (thickness $\approx 14\mu\text{m}$) on a P
84 type substrate. This 0.35 CMOS-Opto process offers 4 metallization layers and 2
85 polysilicon layers. Figure 1 shows the cross-section. The saturation current for NMOS is
86 $520\mu\text{A}/\mu\text{m}$ and $240\mu\text{A}/\mu\text{m}$ for PMOS, which is ideal for the transistor quenching. P-epi
87 wafers allow lower current leakage in the diode, then a lower dark current for a better
88 sensitivity. The Dark current $< 45\text{pA}/\text{cm}^2$ is very low, which is ideal for the Geiger mode.
89 This technology is sensitive in the range $400\text{--}1000$ nm. There are 3 p-type layers of
90 different doping levels to suitably modify the field distribution across the structure. The
91 first one is a thin p⁺ type layer used for a good contact of the photodiode anode (doped
92 Boron $1.10^{20}\text{atom.cm}^{-3}$). The second one is a p-epi-layer (doped Boron $1.10^{17}\text{atom.cm}^{-3}$). The

93 third layer is a heavily doped p⁺layer (substratedoped Boron 3.10^{18} atom.cm⁻³). There are
94 2 n⁻typelayers of different doping levels.The first one is a thin n⁺type layervery sensitive
95 to the light(doped Phosphorus 1.10^{19} atom.cm⁻³). The second n⁻layer is theguard ring (doped
96 Boron 1.10^{17} atom.cm⁻³).These doping values were found by SIMS and the profiles will be
97 published soon. We expose the results obtained in simulation with these doping values.
98 The Figure 2 presents a first simulation of the structurewith the 4 zones and the doping
99 correctly adjusted. The software "Silvaco" was used for these simulations. The result of
100 these simulations at 22.5°C(Figure 3) gives us a breakdown voltage of 11.7V and a guard
101 ring of 40V.At this point of our work, we can say that this technology is well suited to Geiger
102 Mode.

103 **3 Experimental results: Breakdown voltage**

104 We present here the experimental results obtained for several photodiodesof different
105 diameter. These are isolated photodiodes. The diameter of the photodiodes is between
106 $D=200\mu\text{m}$ and $D=2.7\mu\text{m}$ (200,100,50,20,10,7,6,5,4,3 and 2.7) μm . The size of the guard
107 ring is $1.7\mu\text{m}$. The structural dimension is shown in Figure 4.The breakdown voltage
108 values have been determined from the reverse current–voltage (I–V) characteristics,
109 using aKeithley2636A. A breakdown voltage of 11.7V was measured at 22.5°C for
110 photodiodes with a diameter greater than or equals to $10\mu\text{m}$. For photodiodes with a
111 diameter lower than $10\mu\text{m}$ diameter we measured a higher breakdown voltage (near of
112 guard ring 40V) (Figure 5). Measurements have been repeated on a significant number
113 of devices, showing a very good uniformity of the breakdown voltage values and
114 confirming the reliability of the technology used for the Geiger mode.We measured on
115 Figure 6 the temperature sensitivity for breakdown voltage: $9\text{mV}.\text{°C}^{-1}$. It is found that
116 the temperature has a strong influence on breakdown voltage and therefore on the
117 overvoltage.

118 **4 Experimental results: Dark count rate**

119 This is a first positive result concerning the dark count rate (DCR)using only one
120 isolated photodiode. The behavior of the quenchingsystem is correct.At 22.5°C the dark
121 count rate, for a photodiode of $D=10\mu\text{m}$ diameter, and an 800mV overvoltage, is
122 $2020\text{count}.\text{s}^{-1}$ (Figure 7).At -40°C the dark count rate, for a photodiode of

123 D=10 μ m diameter, and an 800mV overvoltage, is 270 count.s⁻¹(Figure 8).These two
124 results are presented in Figure 9. The Figure 10, resume all these results. With a
125 diameter lower than 10 μ m, the DCR does not diminish anymore which confirms that the
126 smallest diameter for this technology is about D=10 μ m.The Geiger pulses were
127 measured with a universal counter "Hameg HM 8021-4".These values are comparable to
128 those reported in literature for CMOS SPADs built in a similar technology:
129 AustriaMicroSystems technology 0.35 μ m high-voltage:[Ref 6].

130 **5 Experimental results: The noise distribution (DCR distribution) and** 131 **Simulation results**

132 These results are new. We measured the time between each pulse. We present on the
133 Figure 11 the DCR distribution. We used a small photodiode: dimension D=10 μ m. With
134 these results we can calculate the probability occurrence of one pulse as shown Figure
135 12. The Figure 12 allows us to build a photodiode model with experimental values of
136 DCR.We simulate Figure 13 an array of photodiodes 1024 and we can calculate the
137 probability of double or triple pulse.

138

139 **6 Conclusion**

140 We introduced in the present document an investigation of the technology "CMOS-Opto
141 C35B401" proposed by CMP (Circuit Multi-Projects) in Grenoble and manufactured by
142 AMS (Austria Micro-system) for the Geiger mode.The main part of our work dealt with
143 the Characteristics in the dark and allowed to find the size of the photodiode with the
144 smallest DCR.The first results that we have obtained are in good agreement with the
145 challenge of the Geiger mode.Other results will be reported in a forthcoming paper.

146

147 Une ou deux phrases sur la dispersion du bruit

148

149

150

151 **7 References**

152

153 Ref 1 :Niclass, C., Rochas, A., Besse, P. A., Popovic, R., & Charbon, E. (2006). A 4 μ s integration time imager
154 based on CMOS single photon avalanche diode technology. Sensors and Actuators A: Physical, 130, 273-281.

155 Ref 2: D. Renker “Geiger-mode avalanche photodiodes, history, properties and problems” Nucl. Instrum. Meth.
156 A 567 (2006) 48-56

157 Ref 3: D. Renker, Geiger-mode avalanche photodiodes, history, properties and problems, Nucl.
158 Instrum.Methods Phys. Res., Sect. A, 567 2006 48-56

159 Ref 4: Vilà, A., Arbat, A., Vilella, E., &Dieguez, A. Geiger-Mode Avalanche Photodiodes in Standard CMOS
160 Technologies.

161 Ref 5: Mandai, S., Fishburn, M. W., Maruyama, Y., & Charbon, E. (2012). A wide spectral range single-photon
162 avalanche diode fabricated in an advanced 180 nm CMOS technology. Opt Express, 20(6), 5849-5857.

163 Ref 6: Tisa, S., Guerrieri, F., & Zappa, F. (2008). Variable-load quenching circuit for single-photon avalanche
164 diodes. Optics express, 16(3), 2232-2244.

165 Ref 7: V. Saveliev, V. Golovin, Nucl. Instr. and Meth. A 442(2000) 223

166

167

168

169

170

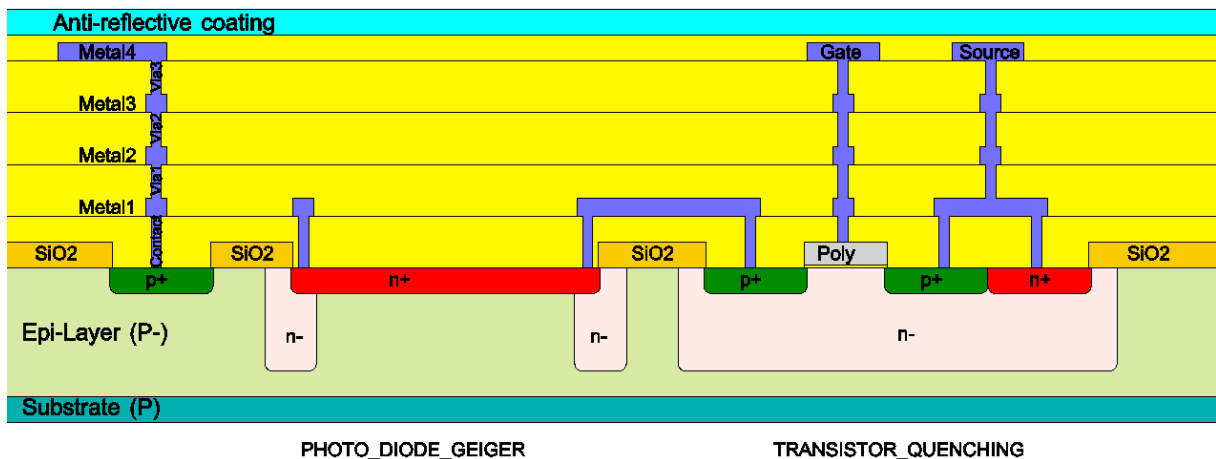

171

172 Figure 1: Cross-section of the Photodiodes design (SPAD)for Geiger mode in CMOS-Opto C35B401

173

174

175

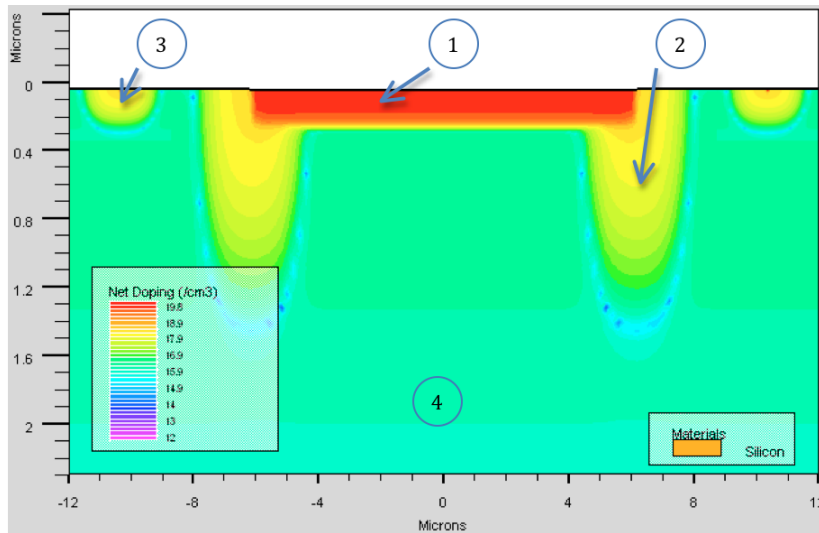

176

177

Figure 2: Cross-section, simulation "Silvaco" of the structure: N⁺/P junction and guard ring N⁻ layer.

178

179

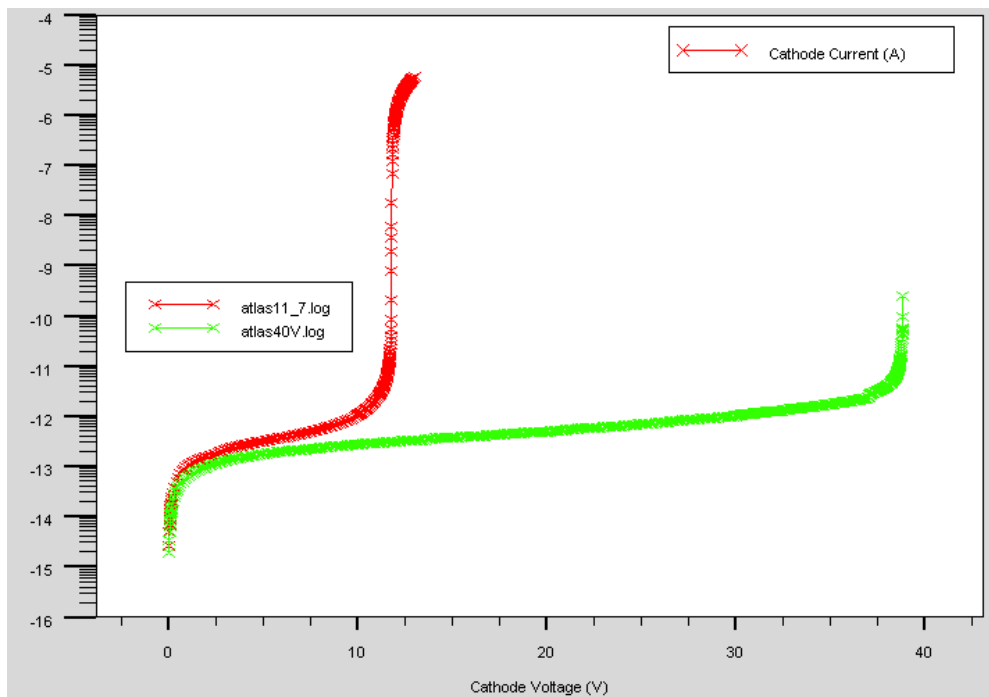

180

181

Figure 3: breakdown voltage of the photodiode and breakdown voltage of the guard ring; simulation results

182

obtained at 22.5°C

183

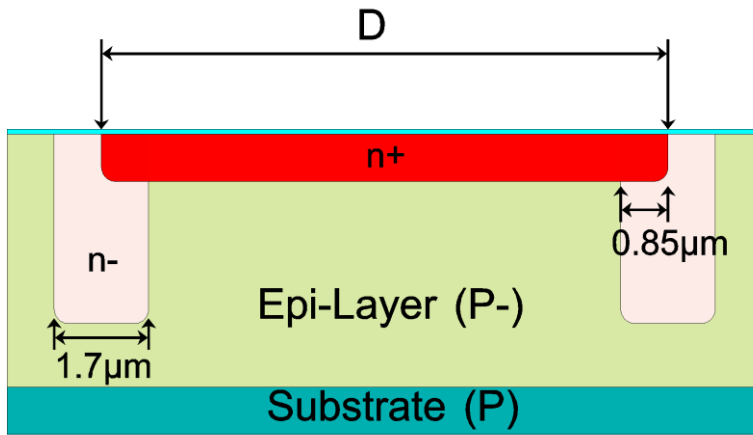

184

185

Figure 4: Schematic structure: Size of guard rings and size of photodiodes

186

187

188

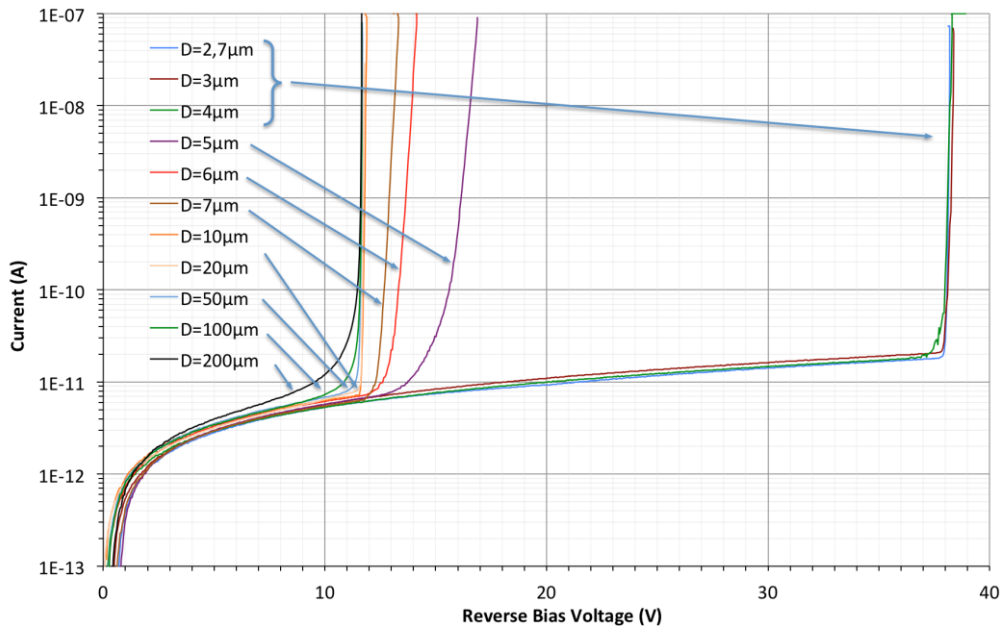

189

190

Figure 5: Breakdown voltage of the photodiodes; experimental results obtained at 25°C

191

192

193

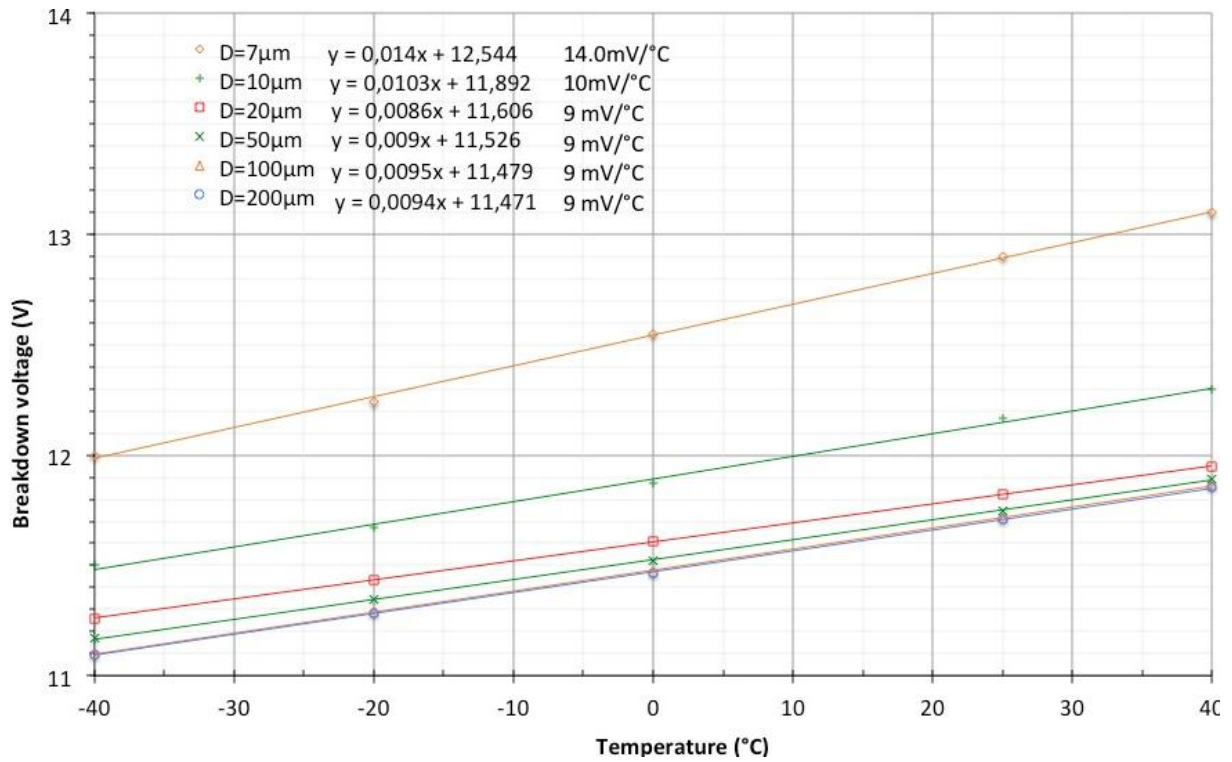

194

195

Figure 6: Breakdown voltage versus temperature for different size

196

197

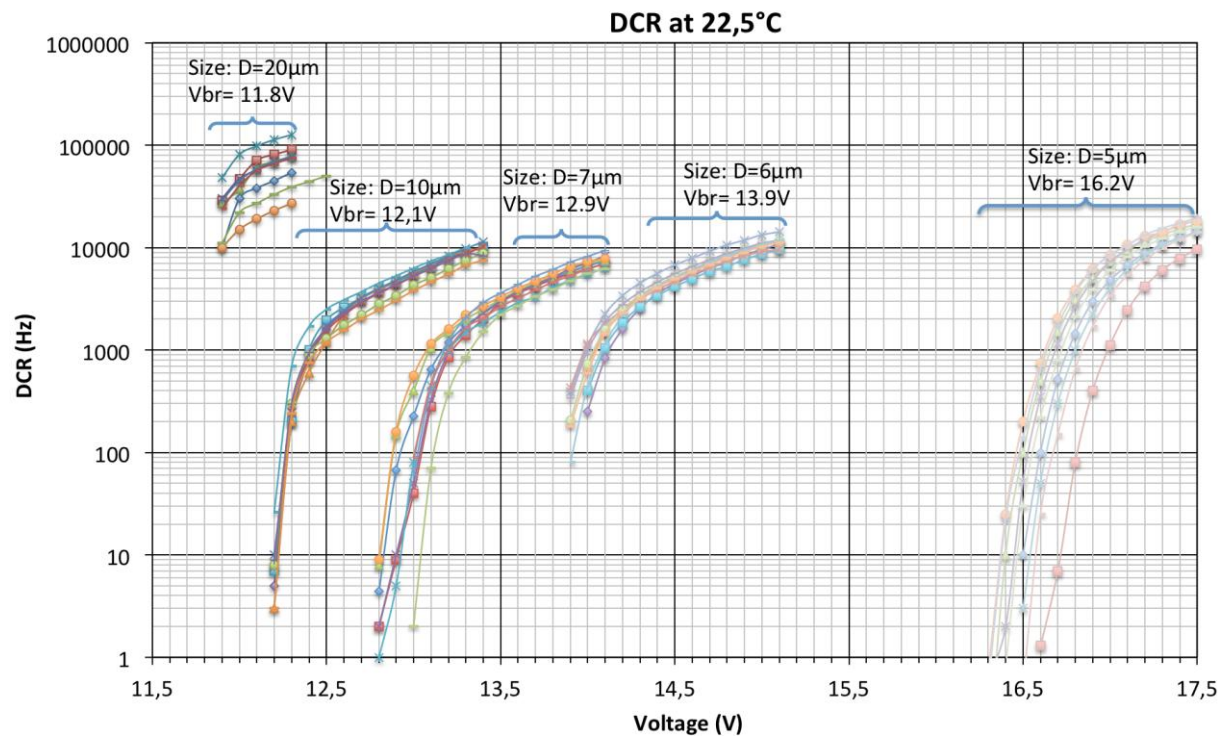

198

199

Figure 7: Dark count rate versus photodiode voltage at 22.5°C.

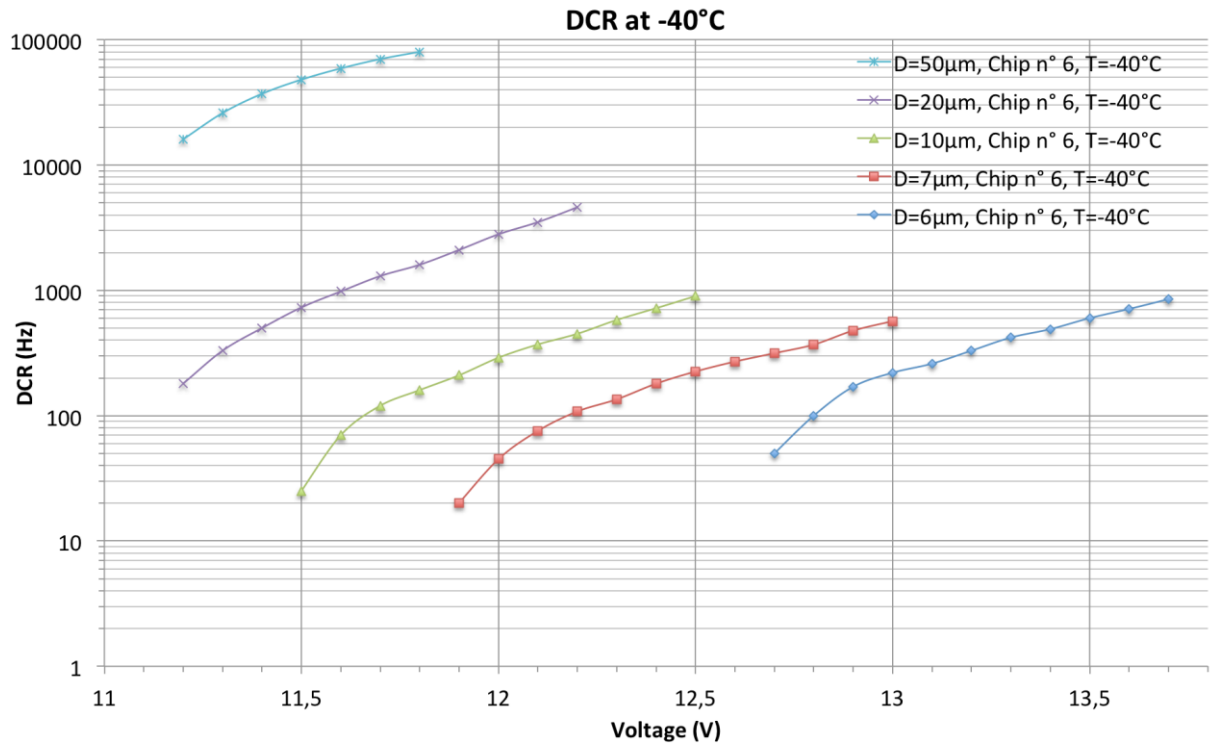

200
201
202

Figure 8: Dark count rate versus photodiode voltage at -40°C

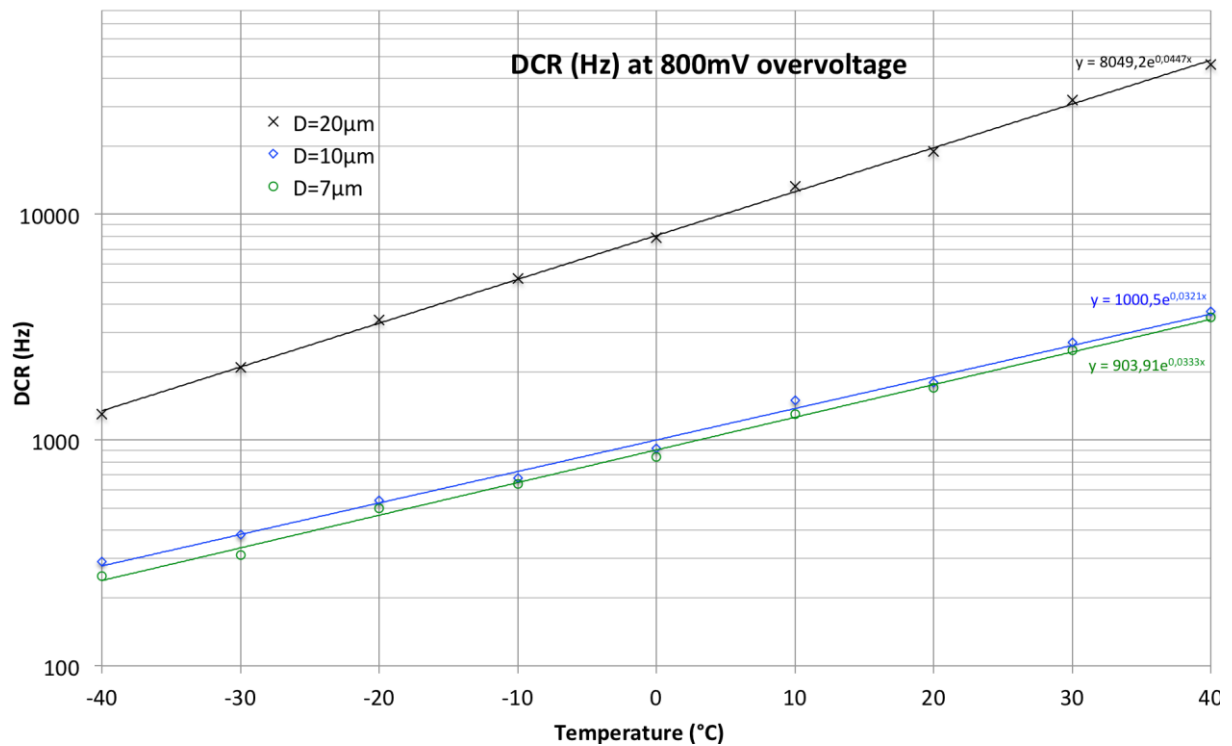

203
204
205
206

Figure 9: Dark count rate versus Temperature for three size at 800mV overvoltage

207
208
209

D (μm)	22.5°C		-40.0°C	
	Vbr (V)	DCR at 800mV overvoltage (Count/s)	Vbr (V)	DCR at 800mV overvoltage (Count/s)
200	11.70	overflow	11.15	overflow
100	11.70	overflow	11.15	overflow
50	11.70	65000	11.15	45000
20	11.80	21000	11.18	1200
10	12.10	2020	11.49	270
7	12.90	1900	11.80	260
6	13.90	1900	12.40	260
5	16.20	1900	15.60	260

210
211

Figure 10: summary table of our design

212
213

214
215

216
217

Figure 11: The nose distribution

218
219

Figure 12 :probability of occurrence over time

220
221

Figure 13 : Simulation DCR of a photodiode array